

# SCUOLA PRIMARIA PONTE NUOVO . RAVENNA

LDA.iMdA ARCHITETTI (capogruppo)





CHI

LDA

.iMda

capogruppo

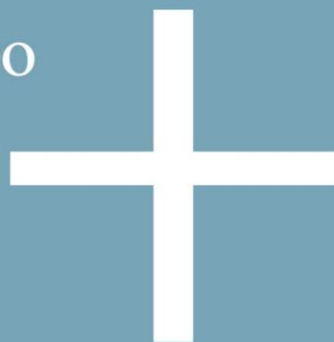

STUDIO TECNO srl

STUDIO MANNORI&associati geologia tecnica

arch. GIACOMO BENVENUTI

arch. EMMANUELE BORTONE

arch. NICO FEDI

arch. PAOLO OLIVERI

ing. SIMONE PAGNI

arch. DARIO VIVALDI



PER  
CHI



DO  
VE

PONTE NUOVO  
RAVENNA



# PNNR



UNA SCUOLA IN DUE SCUOLE



UNA SCUOLA IN UN'UNICA SCUOLA



SUPERFICIE COPERTA ~2400 MQ



SUPERFICIE COPERTA ~2500 MQ

COMPLETAMENTO DELL'OPERA ENTRO IL 30/06/2026!

# SCUOLA CECI

DEMOLIZIONE  
~ 730 MQ CIRCA







SCUOLA  
GULMINELLI

DEMOLIZIONE  
~ 1700 MQ CIRCA



# IL PROGETTO

SCUOLA PRIMARIA  
PONTE NUOVO RAVENNA

IN NUMERI  
375 ALUNNI  
15 AULE + 6 AULE SPECIALI

CIRCA IN METRI QUADRI  
2990<sub>MQ</sub> DIDATTICA  
1400<sub>MQ</sub> PALESTRA  
=  
~ 4390<sub>MQ</sub> TOTALI

IN  
ARMONIA  
CON IL SUO  
INTORNO

SCUOLA PRIMARIA

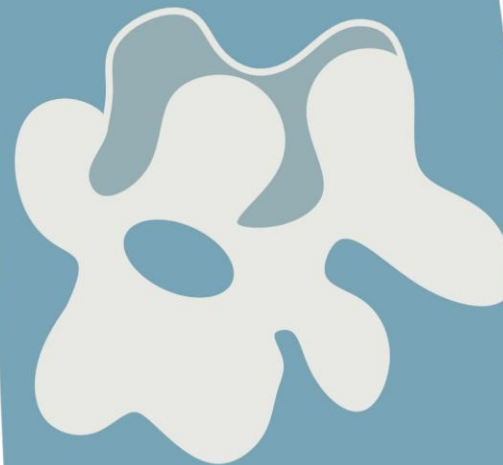
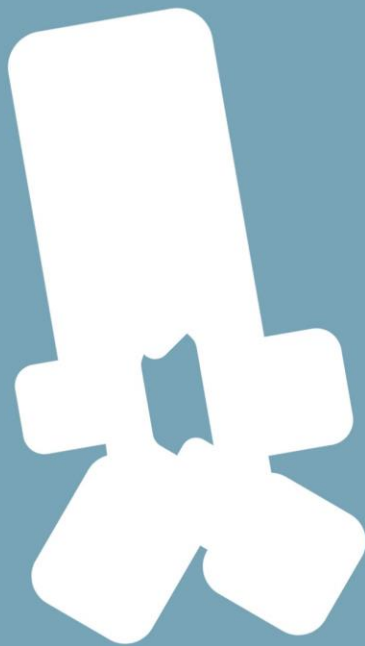

POLO 0-6

\*oggetto di precedente  
progetto-futura realizzazione  
NON incarico LDA.iMdA

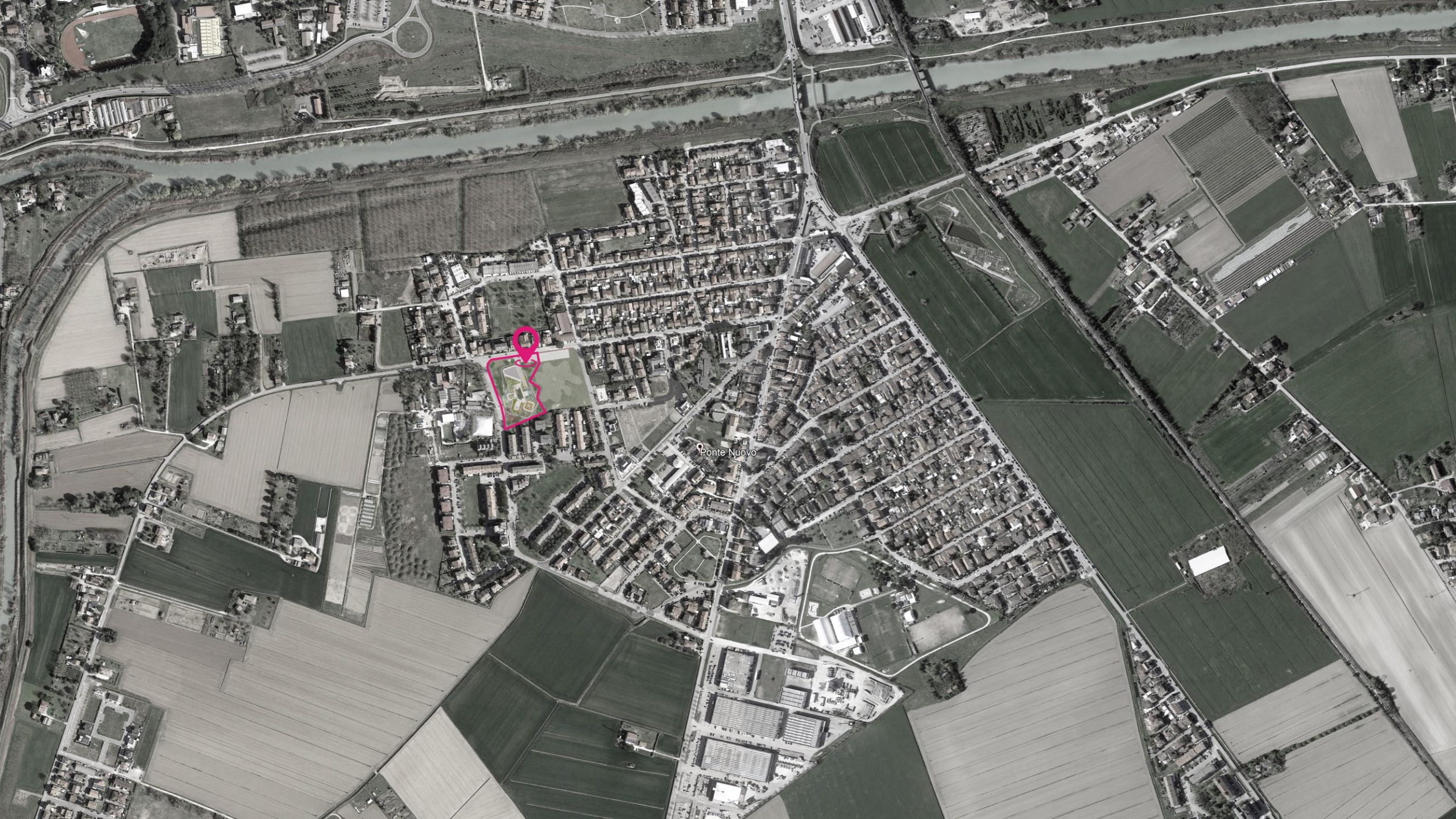

Ponte Nuovo





Scuola Primaria



Allium schoenoprosom



Dianthus carthusianorum



Aster amellus



Gallium verum



Aster linosyris



Gypsophila repens



Centaurea scabiosa



Leucanthemum vulgare margheritina



- 1 GIARDINO ROCCIOSO
- 2 GIARDINO DELLE ERBACEE SPONTANEE
- 3 GIARDINO DELLA LAVANDA
- 4 AREA GIOCHI ATTREZZATA
- 5 ATTIVITA' DIDATTICA ALL'APERTO
- 6 ATTIVITA' LUDICO MOTORIA
- 7 ORTI DIDATTICI
- 8 GIARDINO SENSORIALE

# GIARDINO DELLE EMOZIONI

1. giardino roccioso
2. giardino erbacee
3. giardino lavanda
4. area giochi
5. didattica all'aperto
6. area ludico motoria
7. orti didattici
8. giardino sensoriale

# ORGANIZZAZIONE DEGLI SPAZI ESTERNI

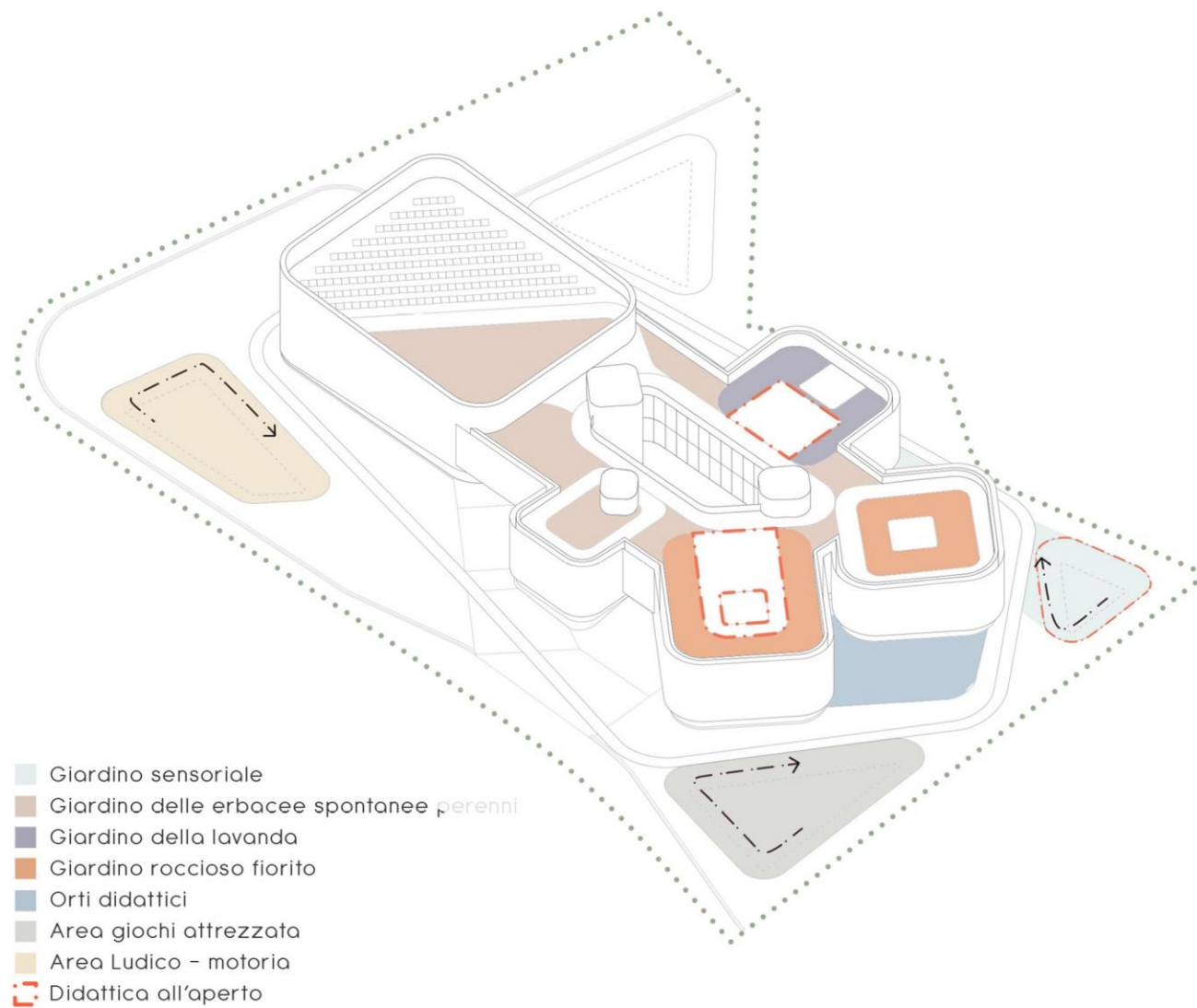



DEPRESSIONI  
COMPENSATIVE

=

ATTENUARE  
IL RISCHIO  
IDRAULICO

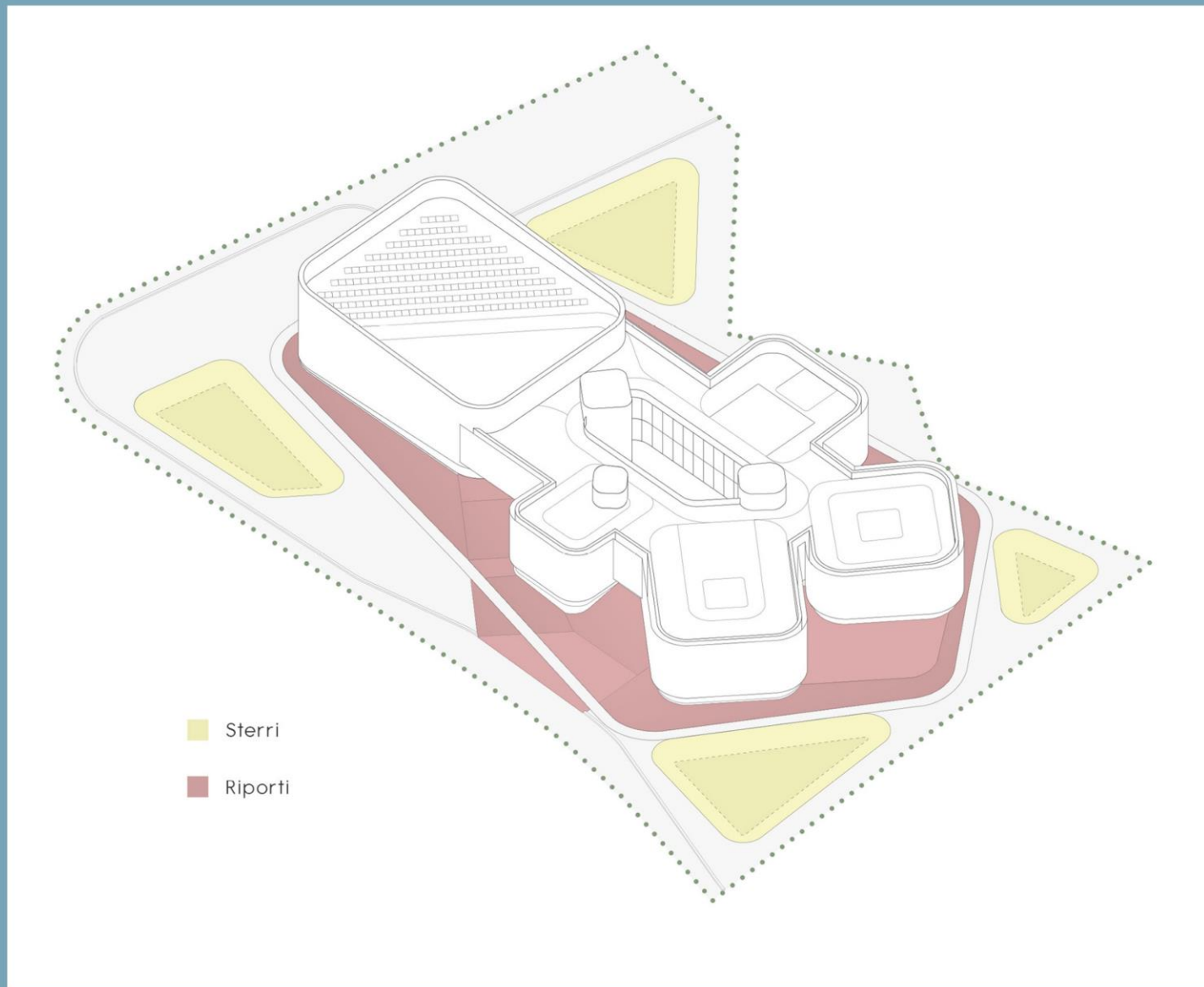

# ACCESSIBILITÀ DELLE AREE ESTERNE

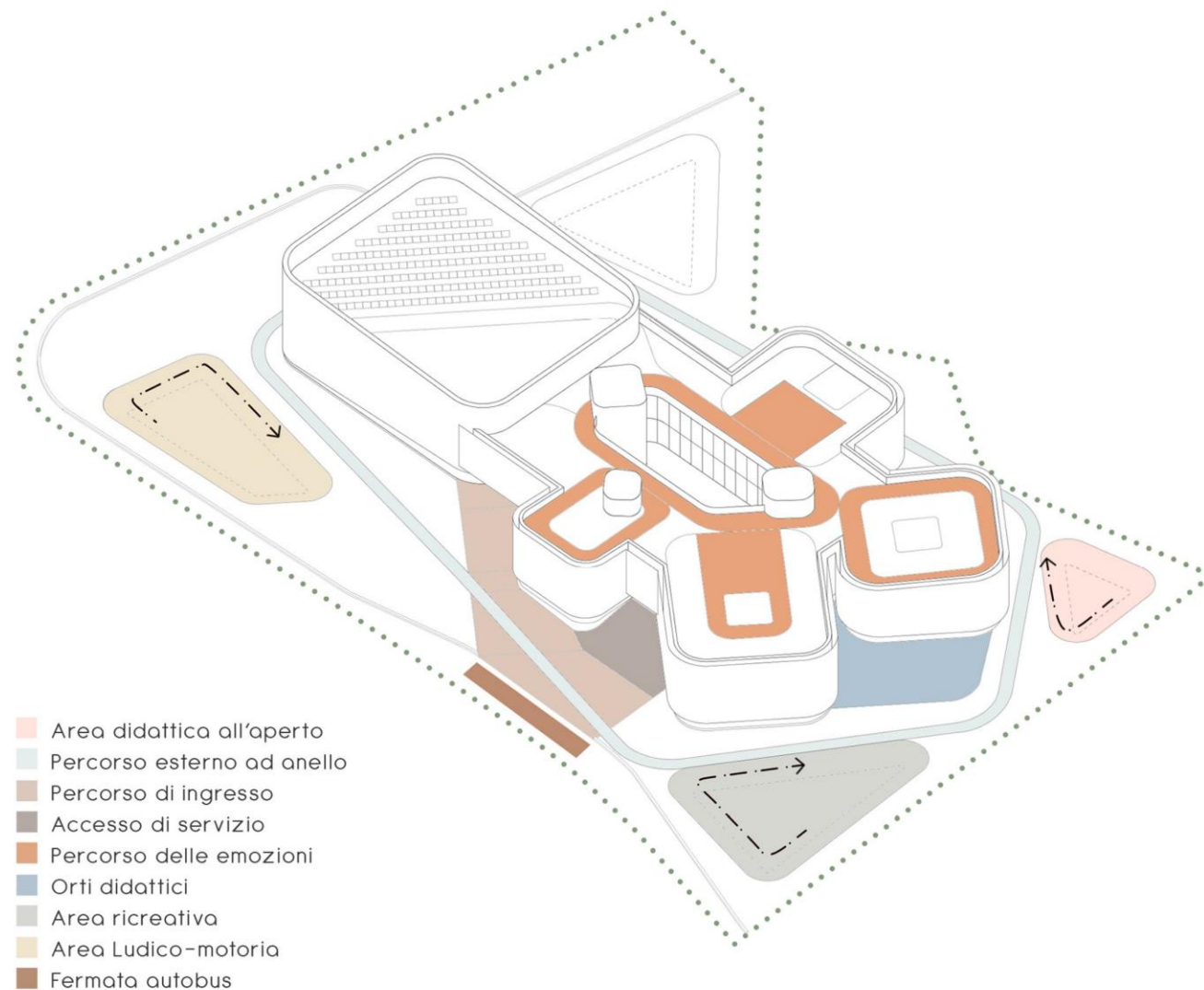

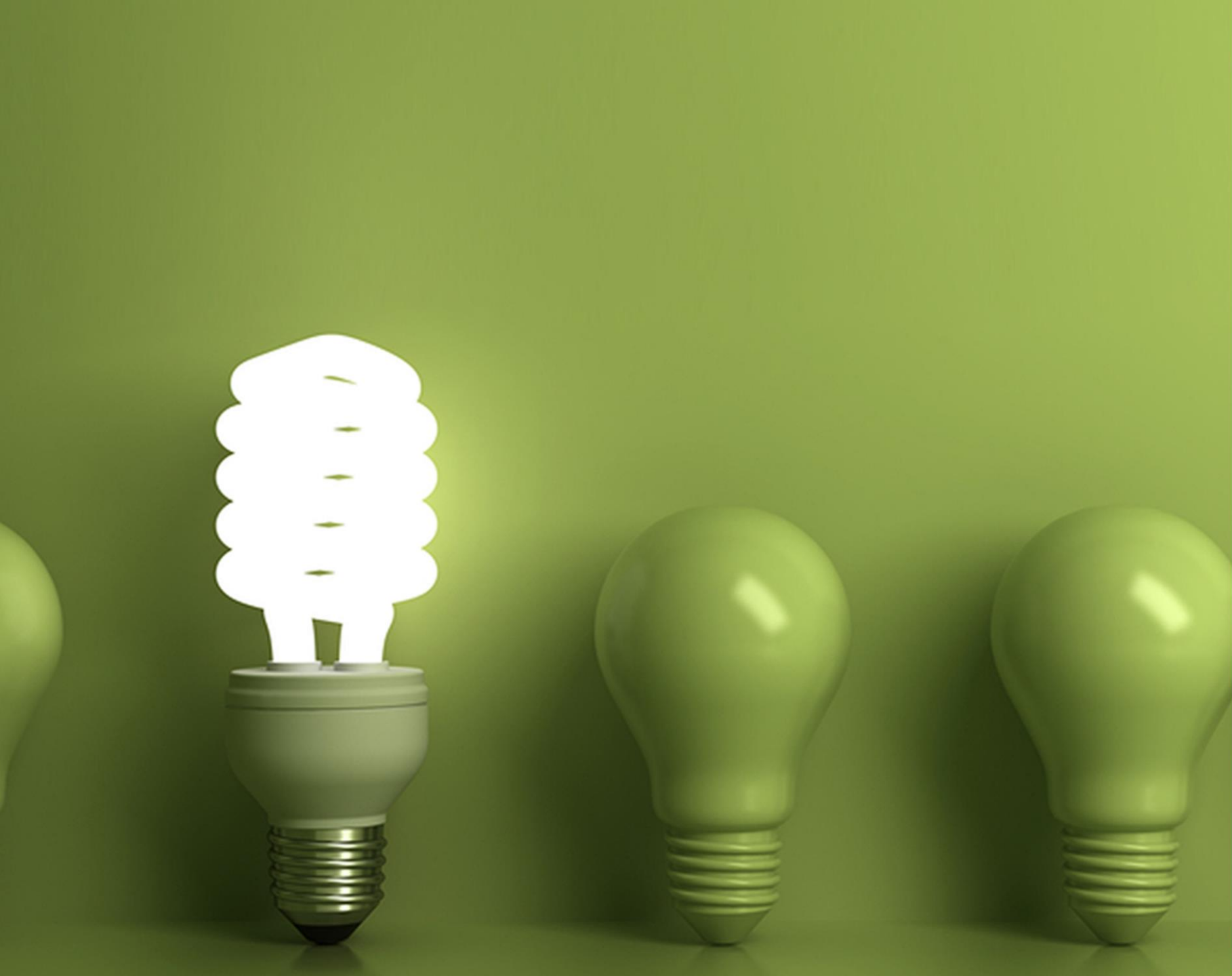

NZEB  
ZERO

- 20%

930<sub>MQ DI</sub>  
FOTOVOLTAICO  
(421 PANNELLI)



PRODURRANNO

~230<sub>MWH</sub>

OGNI ANNO



# ANALISI DEL SOLEGGIAMENTO



# PROGETTO DELLE SCHERMATURE SOLARI

situazione estiva

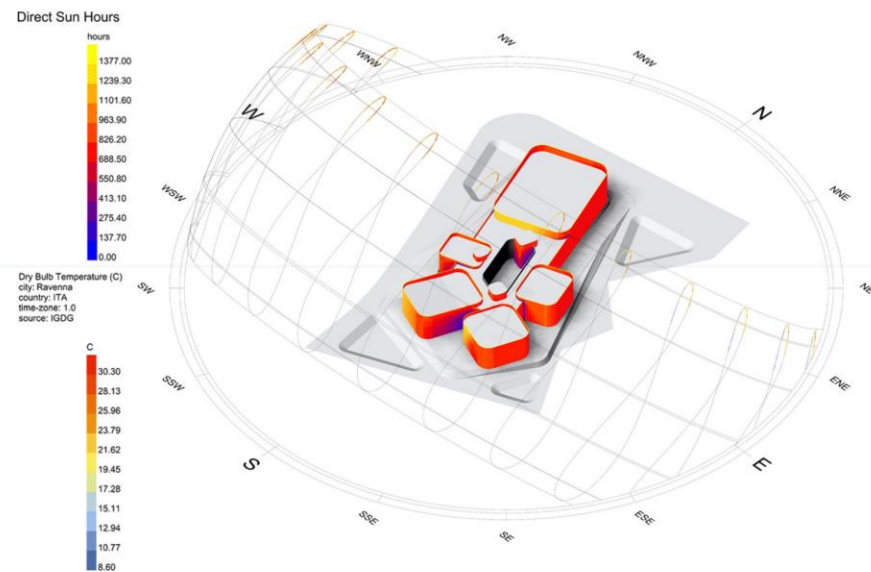

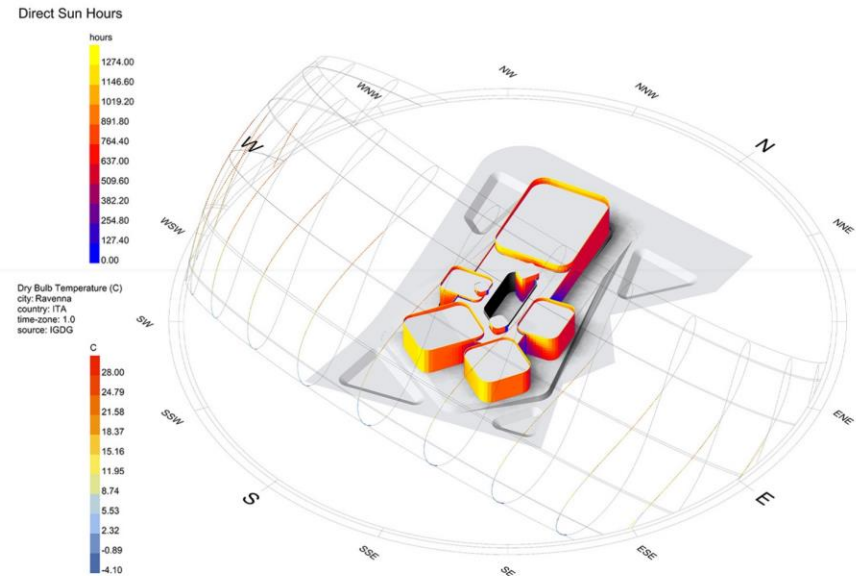

situazione invernale



# ANALISI DEL SOLEGGIAMENTO



# SCHEMATURE SOLARI ADATTIVE

-  schermature espanse e con profilo ridotto
-  schermature di raccordo
-  schermature contratte con profilo maggiorato

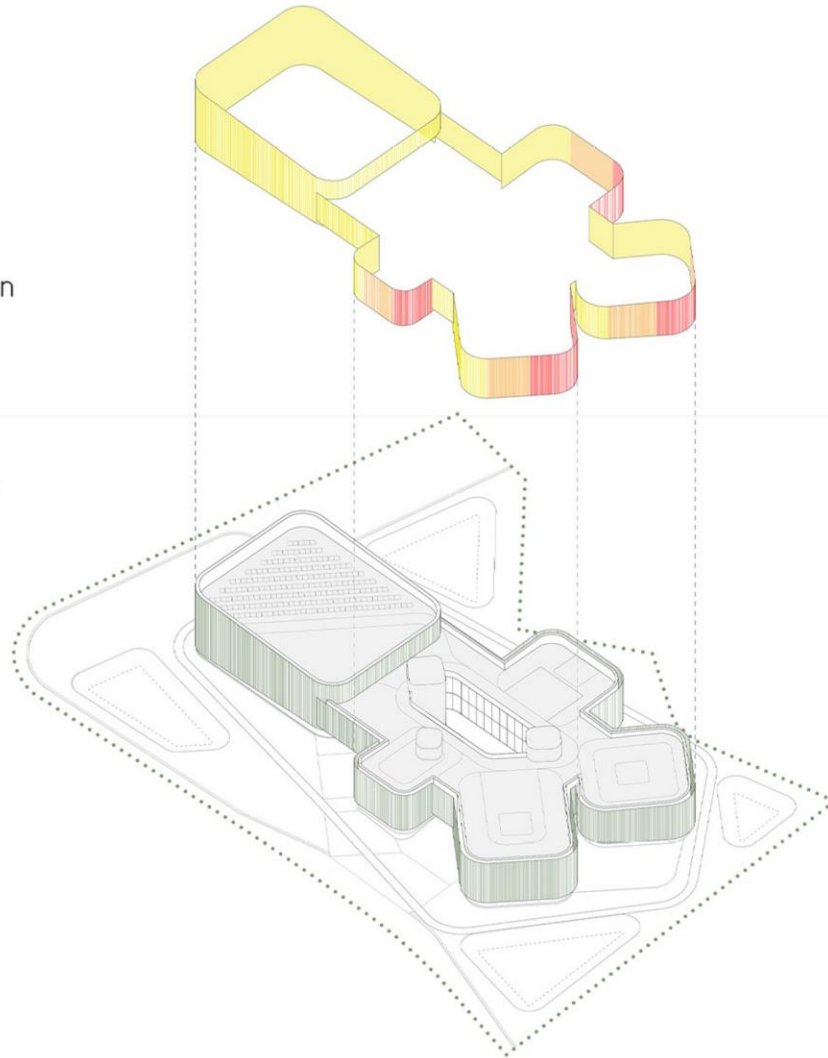

DEPRESSIONI  
COMPENSATIVE



AREE LUDICO  
MOTORIE





ART  
BÜCKEL  
STREET



INVASO  
DALLA  
LUCE  
NATURALE

ATTORNO  
ALLA CORTE  
CENTRALE



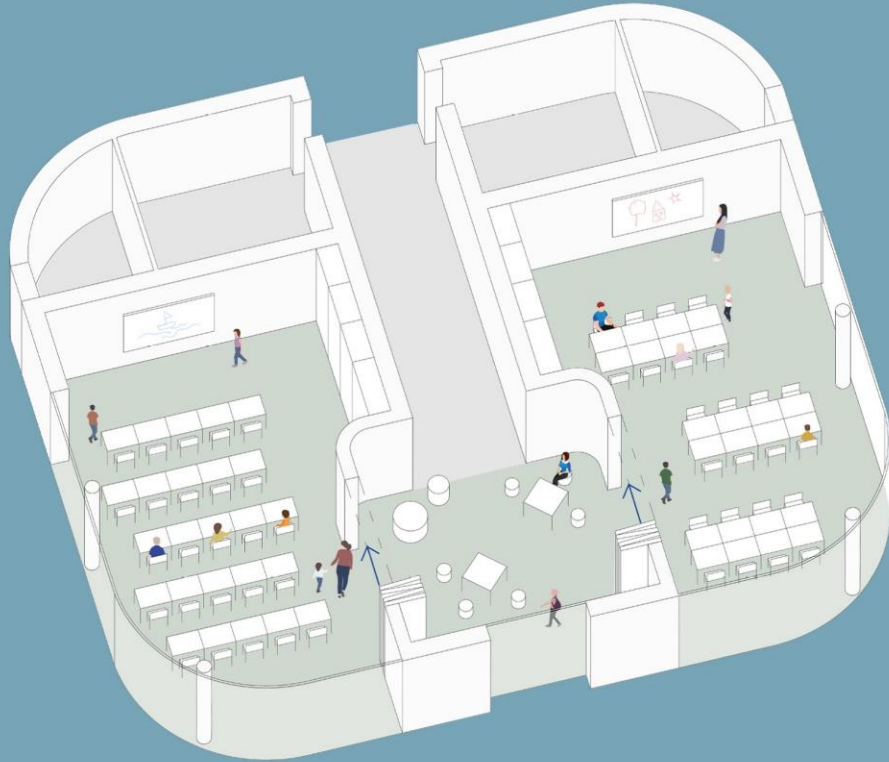

FLESSIBILE

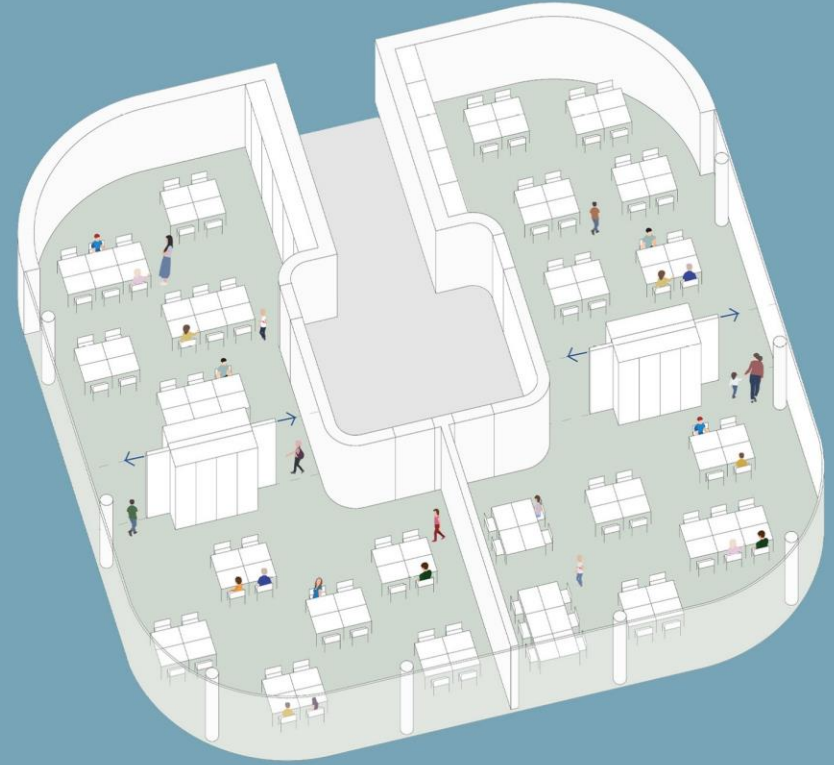

FAVORIRE LE RELAZIONI



DIDATTICA ALL'APERTO

# APERTA ALLA CITTÀ

MINIBASKET  
PALLAVOLO E  
TANTI ALTRI  
SPORT + AMPIA  
TRIBUNA  
SPETTATORI



# PIANTA PIANO TERRA

- 1 INGRESSO CONNETTIVO - 414 mq
- 2 BIDELLERIA / CONTROLLO ACCESSI - 26 mq
- 3 SERVIZI / SPOGLIATOI ADDETTI - 14 mq
- 4 SPAZI PER LA PULIZIA - 4 mq
- 5 AULA FLESSIBILE / BIBLIOTECA - 57 mq
- 6 LOCALE TECNICO - 2 mq
- 7 LOCALE DI SPORZIONAMENTO - 30 mq
- 8 DISPENSA - 8 mq
- 9 SERVIZI / SPOGLIATOI ADDETTI ALLA MENSA - 7 mq
- 10 MENSA - 280 mq
- 11 AULA DIDATTICA O1 - 56 mq
- 12 AULA DIDATTICA O2 - 56 mq
- 13 AULA DIDATTICA O3 - 56 mq
- 14 AULA DIDATTICA O4 - 56 mq
- 15 AULA DIDATTICA O5 - 56 mq
- 16 AULA FLESSIBILE - 31 mq
- 17 AULA DIDATTICA O6 - 56 mq
- 18 SERVIZI STUDENTI - 25 mq
- 19 LOCALE TECNICO - 13 mq
- 20 PALESTRA - 610 mq
- 21 DISTRIBUTIVO PALESTRA - 98 mq
- 22 DEPOSITO - 7 mq
- 23 SPOGLIATOI ARBITRI / INSEGNANTI CON SERVIZI - 32 mq
- 24 SPOGLIATOI STUDENTI CON SERVIZI - 52 mq
- 25 INFERMERIA 15 mq
- 47 AREA DIDATTICA INFORMALE - 25 mq
- 48 SOTTOCENTRALE IMPIANTISTICA - 25 mq

■ SETTI IRRIGIDENTI

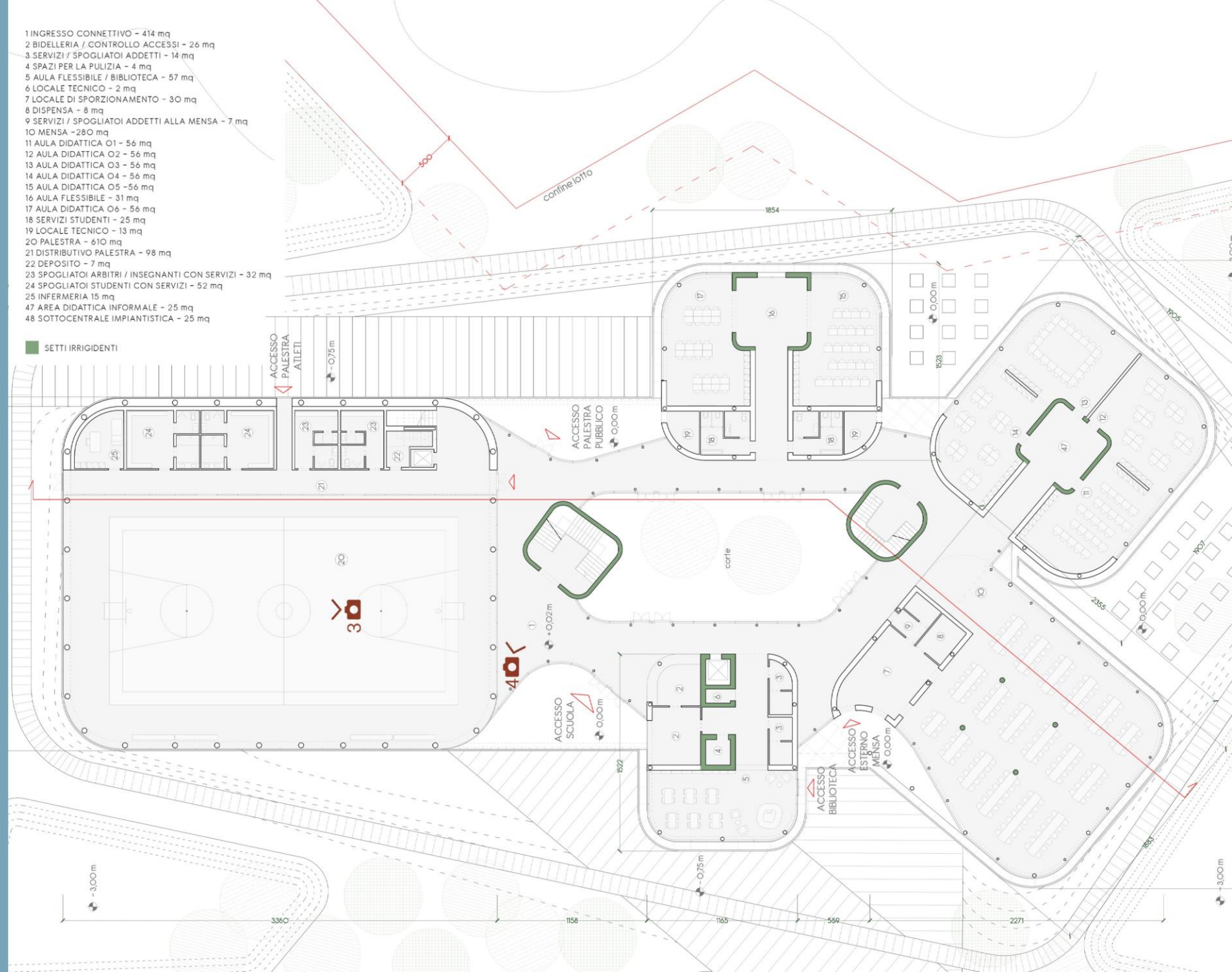

# PIANTA PIANO PRIMO

- 26 SERVIZI STUDENTI - 12,5 mq
- 27 SPAZIO MORBIDO - 28 mq
- 28 SALA INSEGNANTI - 54 mq
- 29 SERVIZI / SPOGLIATOI INSEGNANTI - 14 mq
- 30 AULA INFORMATICA - 60 mq
- 31 AULA FLESSIBILE - 31 mq
- 32 AULA DIDATTICA O7 - 55 mq
- 33 AULA DIDATTICA O8 - 55 mq
- 34 AULA DIDATTICA O9 - 55 mq
- 35 SPAZIO MORBIDO - 32 mq
- 36 AULA DIDATTICA IO - 54 mq
- 37 AULA DIDATTICA I1 - 54 mq
- 38 AULA DIDATTICA I2 - 54 mq
- 39 AULA DIDATTICA I3 - 54 mq
- 40 SERVIZI STUDENTI E DEPOSITO - 19 mq
- 41 SERVIZI STUDENTI E DEPOSITO - 19 mq
- 42 AULA DIDATTICA I4 - 54 mq
- 43 AULA FLESSIBILE - 31 mq
- 44 AULA DIDATTICA I5 - 54 mq
- 45 SERVIZI IGIENICI PUBBLICO - 16 mq
- 46 TRIBUNA - 170 mq
- 47 AREA DIDATTICA INFORMALE - 361 mq

■ SETTI IRRIGIDENTI

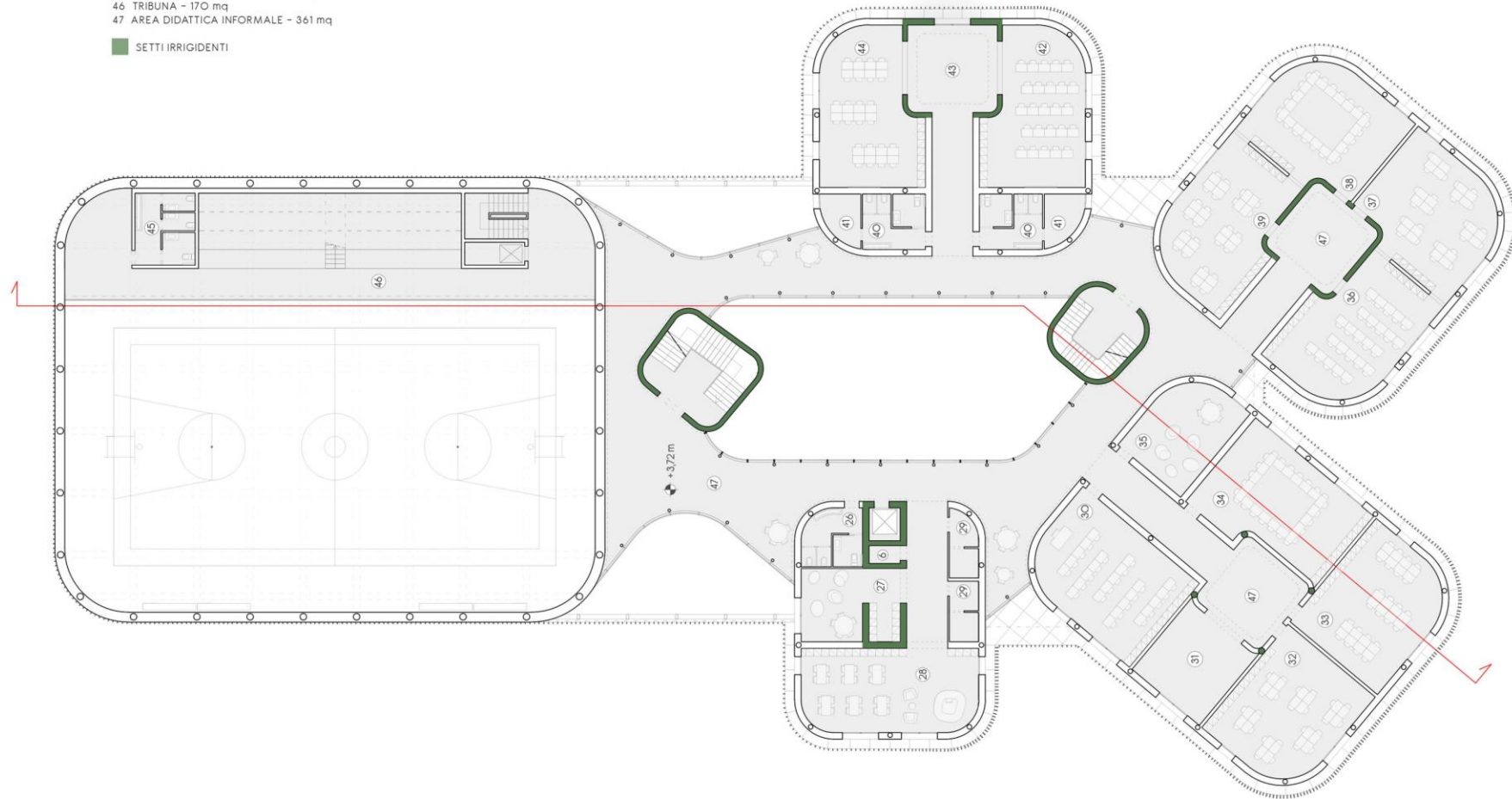





...ED I

RAGAZZI

COME LA

VIVRANNO ?

